

HOSE TAPS

Quarter Turn MI

Product Specifications

Metforge®
brassware

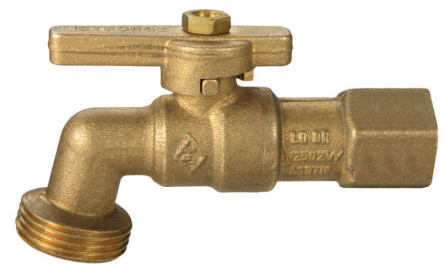
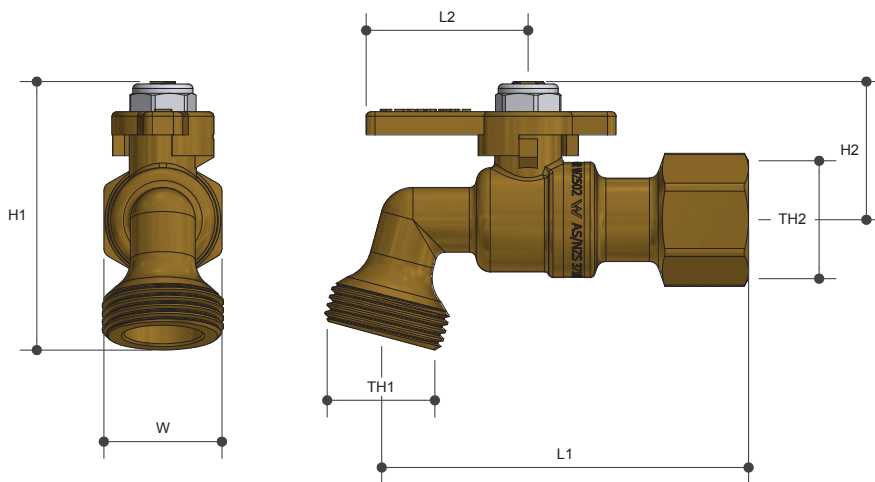

Specifications

Working temperature 1 °C to 75 °C

Maximum pressure rating 1000kPa

Sizing Chart (MM)

	L1	L2	H1	H2	W	TH1	TH2
TH104	79	35	58	30	26	G 3/4"	G 1/2"
TH105	81	35	60	31	31	G 1"	G 3/4"

Features



Watermark approved

100% pressure tested

Available in brass & nickel plated

Blow proof spindle

Tested and certified to AS/NZS 3718

Material Chart

Part	Material
Body	DR Brass
Ball	DR Brass
Spindle	DR Brass
Cap	DR Brass
Nut	Stainless Steel
Seal	PTFE
O Ring	EPDM
Handle	Brass
Aerator	PE

For more information on Metforge, contact:

Austworld 15 Activity Crescent, Molendinar, Queensland 4214 Australia

P. 1300 780 430

F. 1300 780 441

E. info@austworld.com.au

Austworld Pty Ltd. All rights reserved 2018. Austworld and Metforge are registered trade mark belonging to Austworld Pty Ltd.

AW
AUSTWORLD